

# 9000R-6 Receiver

Receiver has 1/2" maximum slot opening for pedestrian safety when bollard is removed.

From 100% Recycled CAST GRAY IRON

Lock Tab automatically drops below grade when bollard is removed.

Gravel base is recommended for drainage.

Concrete profile and sump depth to be determined by installer based on site conditions.

Lock tab opening must be kept clear, protect with tape during concrete pour.

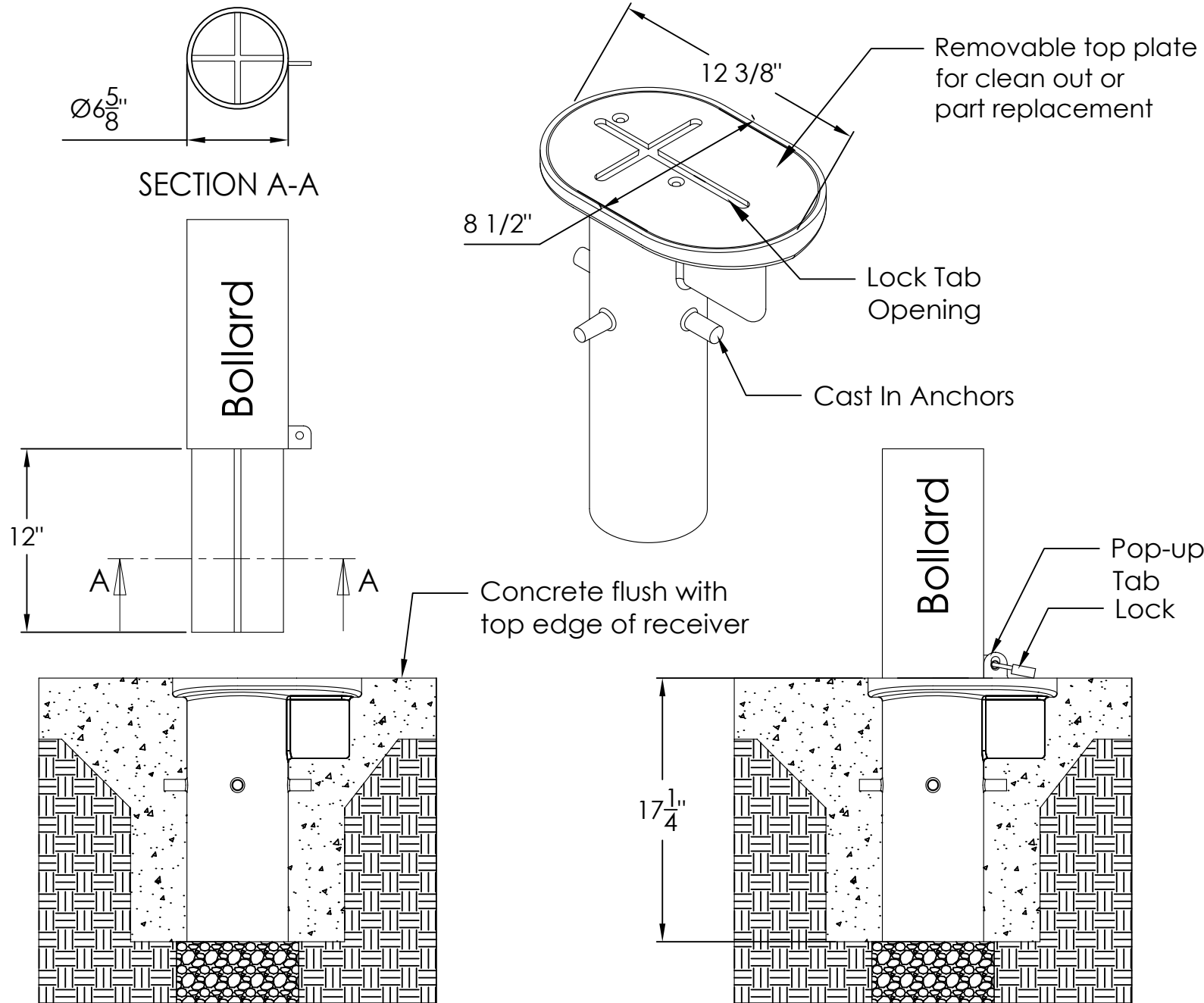

This drawing embodies a confidential proprietary design of IRONSMITH, INC. Palm Desert, CA. All design, manufacturing, reproduction, use, sale and other rights regarding the same are expressly reserved. This drawing is submitted under confidential relationship for a specific purpose and the recipient agrees by accepting this drawing not to supply or disclose any information regarding it to any unauthorized person or to incorporate any special feature peculiar to this design in other projects. The information in this drawing may be covered completely or in part by patents pending.

**IRONSMITH**  
 41701 Corporate Way #3  
 Palm Desert, CA 92260  
 (800)-338-4766  
 www.ironsmith.biz